

4 channel Optical Crossbar 2R/3R with SFP modular ports

MICROSENS

General

MICROSENS Optical Crossbar to connect up to four fiber segments with complete signal regeneration. Due to the complete signal regeneration (3R) of the converter, the signal distortion caused by the transmission over long distances is compensated.

The process of complete signal regeneration is usually called '3R' (reamplification, reshaping, retiming) and regenerates the amplitude, the curvature and the timing of the transmitted signal. The deployment of converters with retiming functionality enables the implementation of far longer transmission distances, and allows cascading several long-distance converters with sub-segment lengths of up to 160 kilometres (99 miles) each depending on the transmitted protocol and fiber specification.

The Optical Crossbar has got installed four modular SFP ports instead of permanent optical modules. The use of pluggable optical transceivers (SFPs) offers the highest flexibility for the implementation of different transmission distances.

Beside this main function of retiming the module can be configured to following operation modes using the integrated crossbar:

- Redundant configuration (protection of fiber links)
- Channel protection (protection of active lasers or complete module)
- Crossbar (all SFP ports freely interconnect able)
- Broadcast (1:n broadcast application)
- Hardware protection (Two cards in master-slave configuration)

By using SFPs with digital diagnostics interface it is possible to monitor the status information of the SFP via the chassis management. It is possible to read information such as wavelength, optical transmit and receive power and other.

The Optical Crossbar converter is laid out in form of a plug-in module card, which is installed into MICROSENS modular converter system. Beside the standalone chassis in single and double version, there are a special 14 and 28 slot 19"-Chassis with 3 HU and 4 HU for mounting up to 12 or 20 modules. In combination with the MICROSENS SNMP management agent module (MS416020-B) the converter can be supervised by SNMP/Web-based management. A further feature places an alarm contact (non-potential), which can be used for the connection to external alarm system.

Connectors

There are following connections on the front side of the module:

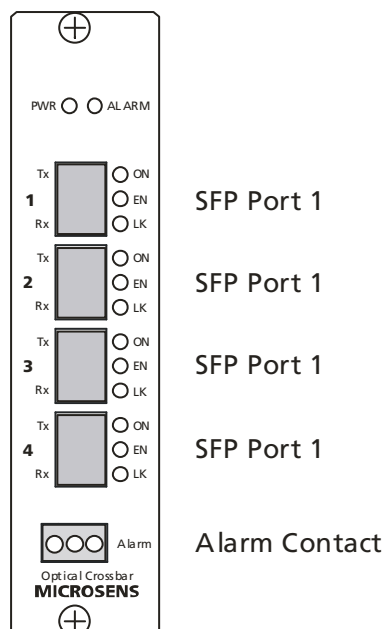

Configuration

Due to a free programmable internal clock the converter does the signal regeneration for any protocol and data rate, e.g. ATM OC-3, SONET/SDH STM-1 (155 Mbps), ATM OC-12/ SONET/SDH STM-4 (622 Mbps), Fibre Channel (1,0625 Gbps), Gigabit Ethernet (1.25 Gbps), Double Rate Fibre Channel (2,125 Gbps), ATM OC-48/ SONET/SDH STM-16 (2488 Mbps), and others within the range of 50 Mbps up to 2.7 Gbps. The signal amplitude (1R), the signal form (2R) and the signal timing (3R) are regenerated. The selection of transmission rate is made via the management of the additional management agent module (MS416020-B).

Link Through

Via the management software it is possible to activate or deactivate the Link Through function.

The Optical Crossbar converter supports Link Through (LT) function in FX/FX retimer application. The link status on one port is propagated to the other port to notice the remote nodes. If one of the fiber ports is unplugged, this converter stops transmission on the other fiber port. See the management section and TX dependence matrix description.

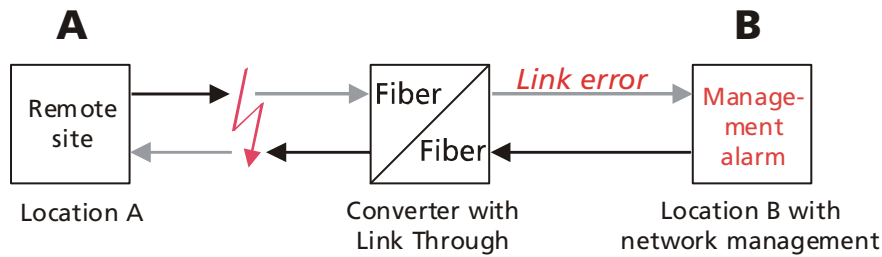

LED displays

The status of the converter is indicated over 15 LEDs on the front side. Two general LEDs for the whole module:

PWR ALARM

LED	Name	Description
PWR	Power	Module is ready
ALARM	Alarm	Alarm is on

Three LEDs for each SFP port:

ON
 EN
 LK

LED	Name	Description
ON	Laser On	Transmit Laser on
EN	Enable	Port able to transmit data In protection mode: On: active protection port Off: standby protection port
LK	Link	Flashing: receiving optical signal On: Retimer lock

Alarm contact

The alarm contact enables the monitoring of the converter condition over an attached external signal generator.

In case of a failure of the power supply of the module the alarm contact switches into the alarm condition.

There are two different options how the alarm is provided at the relay contact, normally open or normally closed. The pin out of the alarm contact is shown in the following figure and table:

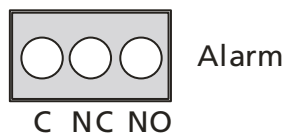

PIN	Name	Description
-----	------	-------------

C	Common	Common contact for NC and NO.
NC	Normally Closed	Closed to common in normal operation, open in case of alarm.
NO	Normally Open	Open to common in normal operation, closed in case of alarm.

When connecting external devices the maximum contact stress of the connection must be considered. **Never connect 230 V AC to this contact!**

Installation options

The Optical Crossbar converter module is intended for the installation into a MICROSENS modular system. It can be combined with all other converter modules of the same series freely. The current supply is made from a central power supply via backplane. Together with the power supply (MS416004 and/or MS416004M - manageable version) maximally 12 modules can be installed into 3HU chassis (MS416001M) or up to 20 into 4HU chassis front and back (MS416010M).

Optionally a second power supply (MS416004M) for redundancy can be installed. In this case 10 modules can be used for MS416001M or 18 for MS416010M. During a partial assembly the unused slots are covered with blind covers (MS416100). The blind covers do not belong to the scope of supplied with the modular chassis.

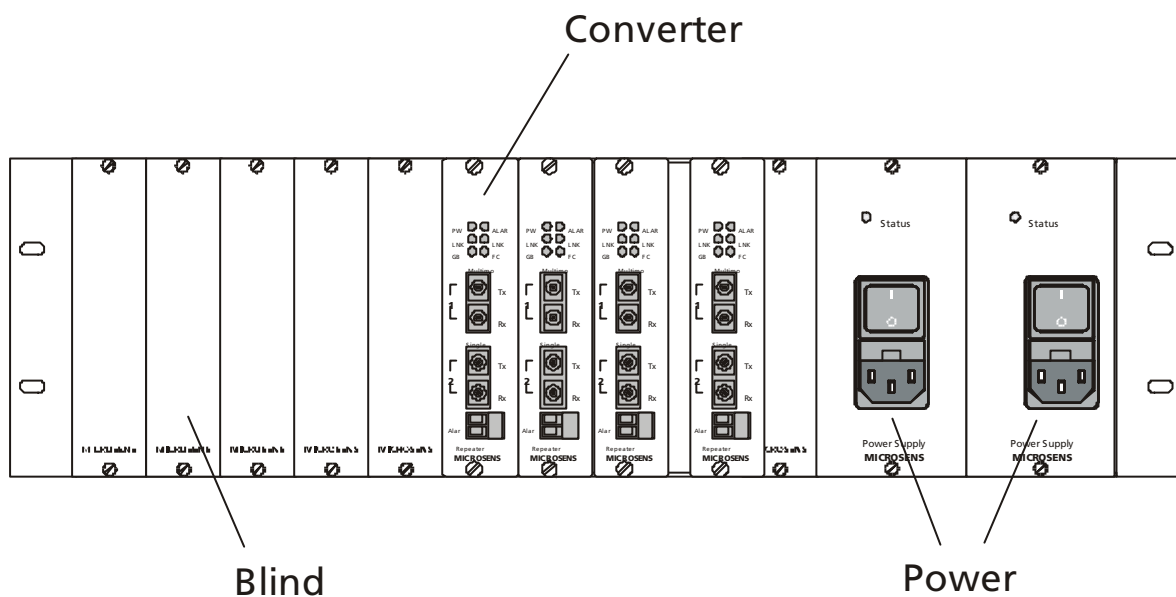

Beside the 3HU/4HU-Chassis a 1HU chassis for 3 modules (inserted crosswise) is available. This chassis has an integrated power supply (MS416006), witch also can be laid out redundantly (MS416007). There are also available standalone chassis for the admission of one module (MS417001) and for the admission of two modules (MS417041).

Management

The SNMP/Web-based management ability of a system is manufactured by the management master module (MS416020-B). In order to be able to access over SNMP the data of the modules, the integration of the data structure of the MIB is necessary into the existing network management. The structure of the MICROSENS MIB can be downloaded by HTTP from the management master. The MIB file is present in the ASCII format.

Installing and configuring the MS416020-B in manageable chassis (e.g. MS416001M) is required for monitoring and configuring Optical Crossbar card via the console, SNMP and http (using any Internet browser).

Web-based Management

Clicking on the module card from *Device Information* view shows *Module Information* page:

Module Information : Slot 6

Article-No.	MS416453MR			
Serial-No.	05240437			
Description	Optical Crossbar			
Firmware-Version	v1.01			
Port-No.	1	2	3	4
Link Status	ON	OFF	ON	OFF
Retimer Lock	OFF	OFF	OFF	OFF
Module Temperature	28 °C			
Protection Status	not active			
Ext. Protection Status	undefined			
Ext. Protection Mode	disabled			
Alarm Status	No alarm			

[Port Information](#)
[Mode Configuration](#)
[Retimer Configuration](#)
[Alarm Configuration](#)

All needed information about the Crossbar module is presented in form of easy-read table. Beside the serial number and status of the card it is possible to monitor all the ports.

For more detailed information click on other links.

Port Information

Using flexible SFP transceivers with diagnostics function e.g. (MS100240D) it is possible to monitor most important parameters for each of four ports. Beside the port identification data there are available information about received and transmitted

optical power per each port and extended diagnostic like laser temperature or bias current.

Port Information : Slot 6

Port Identification	Port1	Port2	Port3	Port4
Article-No.	FTRJ1319P1B	n/a	FTRJ1319P1B	n/a
Serial-No.	P7M01SJ	n/a	P7M01T2	n/a
Wavelength	1310 nm	n/a	1310 nm	n/a

Line Monitoring	Port1	Port2	Port3	Port4
TX-Power	-6 dBm	n/a	-6 dBm	n/a
RX-Power	-8 dBm	n/a	-10 dBm	n/a

Extended Diagnostics	Port1	Port2	Port3	Port4
Laser Temperature	38 °C	n/a	38 °C	n/a
Voltage	3158 mV	n/a	3163 mV	n/a
Bias Current	23 mA	n/a	27 mA	n/a

Reload Back

Mode configuration

Mode Configuration:

Mode of Operation	<input type="text" value="Dual Converter"/>	
Protection Mode	<input type="text" value="auto, revertive"/>	
External Protection	<input type="text" value="disabled"/> <input type="button" value="Configuration"/>	

Information	Port1	Port2	Port3	Port4
Function	conn. to 2	conn. to 1	conn. to 4	conn. to 3

Crossbar	Port1 in	Port2 in	Port3 in	Port4 in
Port1 out	<input type="radio"/>	<input checked="" type="radio"/>	<input type="radio"/>	<input type="radio"/>
Port2 out	<input checked="" type="radio"/>	<input type="radio"/>	<input type="radio"/>	<input type="radio"/>
Port3 out	<input type="radio"/>	<input type="radio"/>	<input type="radio"/>	<input checked="" type="radio"/>
Port4 out	<input type="radio"/>	<input type="radio"/>	<input checked="" type="radio"/>	<input type="radio"/>

TX-dependence	Disable	Port1 Link	Port2 Link	Port3 Link	Port4 Link
Port1	<input type="checkbox"/>	<input type="checkbox"/>	<input type="checkbox"/>	<input type="checkbox"/>	<input type="checkbox"/>
Port2	<input type="checkbox"/>	<input type="checkbox"/>	<input type="checkbox"/>	<input type="checkbox"/>	<input type="checkbox"/>
Port3	<input type="checkbox"/>	<input type="checkbox"/>	<input type="checkbox"/>	<input type="checkbox"/>	<input type="checkbox"/>
Port4	<input checked="" type="checkbox"/>	<input type="checkbox"/>	<input type="checkbox"/>	<input type="checkbox"/>	<input type="checkbox"/>

User Verification: Enter Password	<input type="text"/>
--------------------------------------	----------------------

The insertion module supports four different modes:

- a) Converter
- b) Crossbar
- c) Protection
- d) Protection with double used Backup Line

a) Converter Mode

In the converter mode the crossbar of the insertion module is dedicated and can't be changed via the management. Port 1 and 2 belongs to channel 1 and port 3 and 4 to channel 2.

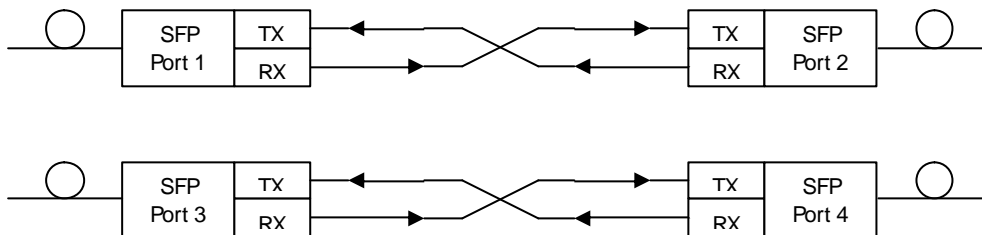

b) Crossbar Mode

In the mode "Crossbar" the connection of the ports among themselves are free adjustable.

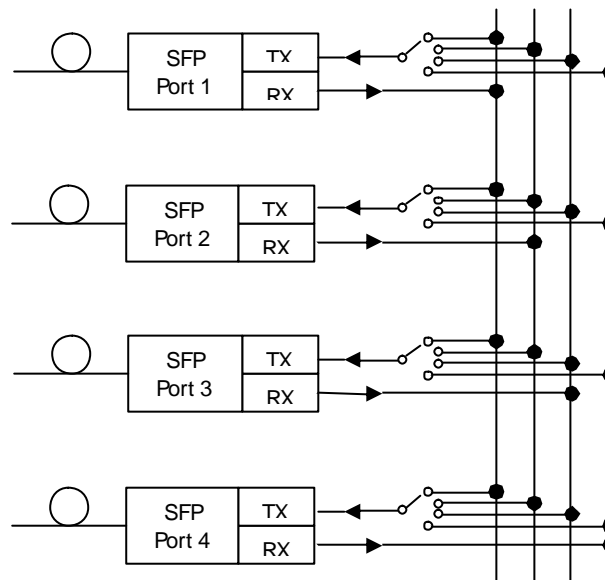

Always the source port for the particular output will be adjusted.

For example: If for the output of port 1 the source port 1 will be set up, the incoming signal at port 1 will be again emitted at port 1.

The signal will be looped internal. This can be useful for tests.

Also possible it is to assign the same source port for several outputs. This kind of connection is called "Broadcasting".

c) Protection Mode

With the Protection Mode the meaning of the ports will be specified.

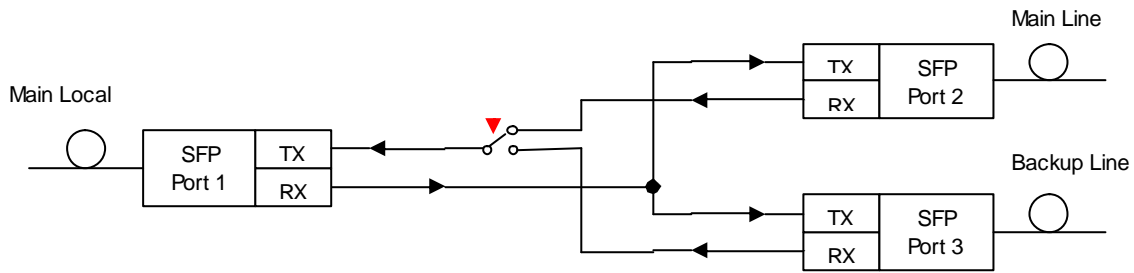

Port 1 is the local port, port 2 is the main connection and via port 3 the backup line will be connected. In this mode the port 4 will not be used.

In the protection mode there are 4 different switching functions available:

1. auto revertive
2. auto non revertive
3. fixed main
4. fixed backup

In the "auto revertive" mode the logic of the insertion module switches at a deficit of the main line link automatically over to the backup line. If again a link will be detected on the main line it will be switched back to the main line.

In the "auto non revertive" mode the logic of the insertion module switches at a deficit of the main line link automatically over to the backup line. The behaviour is identical to the "auto revertive" mode. If again a link will be detected on the main line it will not be switched back to the main line. Furthermore the backup line will be used. Switching over to the main line happens only if the backup line loses the link and a link is detected on the main line.

The both "fixed modes" chooses manually between the main or the backup line.

In these modes the automatic is shutoff. If the line, which had been chosen manually, has lost the link, no automatic engaging will take place to reconnect the link. At "fixed main" the main line is chosen and at "fixed backup" the backup line.

d) Protection with double used Backup Line

In the mode "protection with load rejection" the assignment of the ports is also defined.

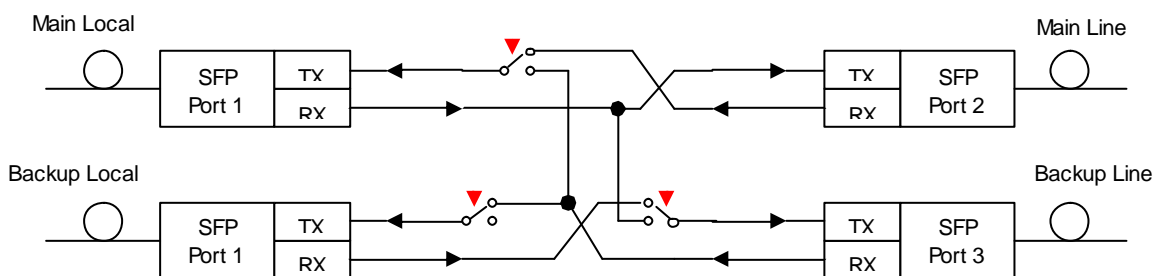

As opposed to the "normal protection mode" the fourth port will be used with in the mode "protection with load rejection".

That means, if both, the "main" and "backup line" have a link the insertion module works like a normal twin converter. If the "main line" failed, the local backup port will be cut off and the main port will be switched over the backup line.

The backup line is used only in fault for the main line. If no fault occurs, the backup line is available via the backup local. This logic makes sense, if a backup line should be used for diverse backups and it suffices to protect one fault.

Retimer Configuration

The *Retimer Configuration* settings are used for enabling/disabling and configuring the retimer unit being a part of Optical Crossbar module. It is possible to choose one of many protocols for the crossbar and depending on the needs to enable retimer functionality for each of the ports. Only one protocol can be retimed by the crossbar at a time (each channel must operate with the same speed in retiming mode). After changing the configuration the verify password must be typed correctly.

Retimer Configuration:

Protocol Type Selection	Gigabit Ethernet	
Port Configuration	TX-Retimer Enable	retimed Protocol
Port 1	<input type="checkbox"/>	protocol transparent
Port 2	<input type="checkbox"/>	protocol transparent
Port 3	<input type="checkbox"/>	protocol transparent
Port 4	<input type="checkbox"/>	protocol transparent
User Verification: Enter Password	<input style="width: 100%;" type="text"/>	

Alarm Configuration

In this menu it can be configured which events will cause activation of alarm relay contact of the crossbar module.

Technical Specifications

Type	4 channel Optical Crossbar 2R/3R module to connect up to four fiber segments with integrated crossbar, protection and broadcast feature	
Connectors	4x modular SFP ports	
Data rate	50 Mbps up to 2.7 Gbps (free configurable internal clock)	
Bit Error Rate (BER)	< 10 ⁻¹² (within the parameters of the SFPs)	
LED displays	<i>PWR</i>	Standby
	<i>ALARM</i>	Fiber link error or power down
	<i>ON</i>	Laser on
	<i>EN</i>	Port enabled
	<i>LK</i>	Link / clock locked
Alarm contact	potential free, max. 60 V DC, max. 0.5 A	
Power supply	12 V DC / max. 400 mA via Backplane	
Operating temperature	0°C to 55°C	
Storage temperature	-20°C to 80°C	
Relative humidity	5% to 80% non condensing	
Dimensions	3 HE x 6 TE (128 x 31 mm)	

Order information

Article no.	Description	Connectors
MS416453MR	4 Channel Optical Crossbar + Wide Range Retimer Module up to OC-48/STM-16, 4x modular SFP Ports	4x SFP Ports Alarm contact

Because of the constant development and improvement of our products MICROSENS reserves the right to make changes without notice at any time. (5107dh)